

# Furðufugla gríma

með  
hönnunarteymi

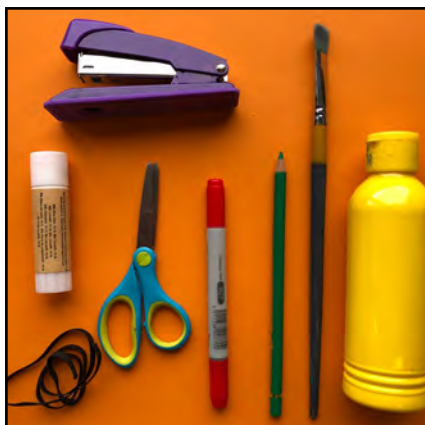



1. Efni sem þarf; pappír, skæri, liti, heftara, lím og teygju.



2. Prenta út grímu, gogginn og fjaðrir. Hægt er að prenta á allt en betra á þykkann pappír ef þú átt.

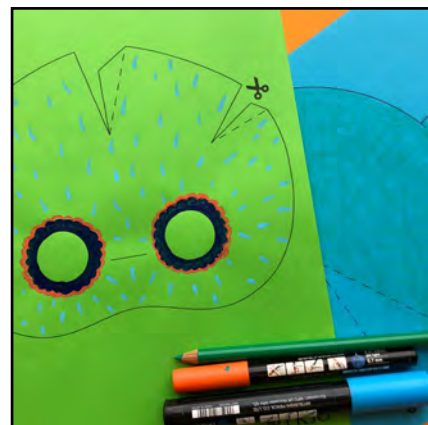

3. Svo má lita á hana eins og þú vilt. Mála, tússa, trélita eða bara ekki lita :)

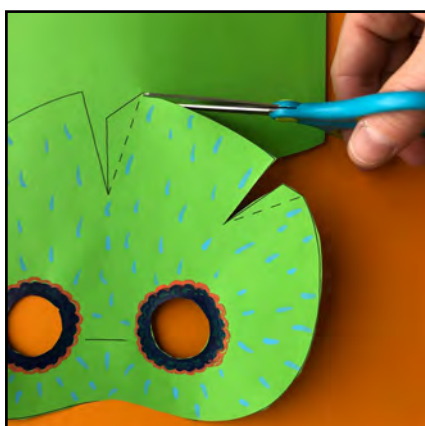

4. Klippa.



5. Ef þú ætlar að nota þennan gogg þá þarf að brjóta hann saman.

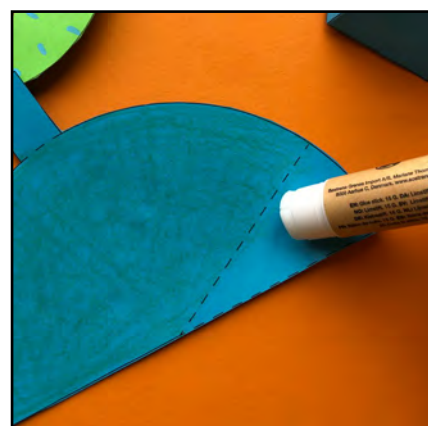

6. Svo má líma.



7. Þá ertu komin með tvo parta.



8. Setja gogginn í rifuna.



9. Líma.



10. brjóta upp.



11. Til að festa teygjuna er gott að setja smá auka pappírs bít til að styrkja grímuna.



12. Hefta teygju við grímuna.



13. Næst á að teikna fjaðrir, mála, tússa, nota lituð blöð eða klippa úr tímaritum, hvað sem þig langar.

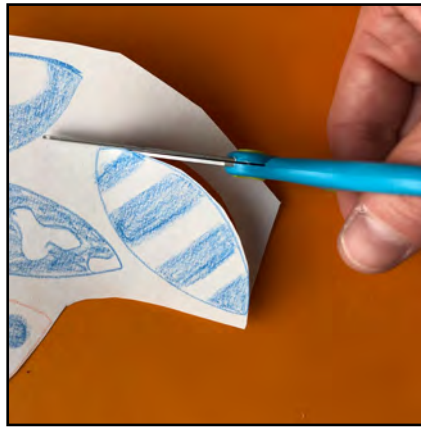

14. Klippa út.



15. Eins margar fjaðrir og þú vilt enn við mælum með allavega 15 fjöðrum.



16. Setja lím aftan á fjöðrina.

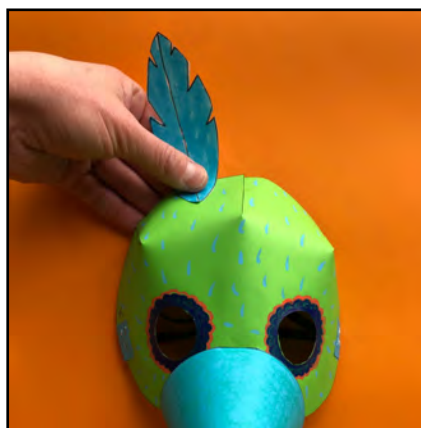

17. Festa á grímuna



18. Hvar sem þú vilt



19. Og þá er hún tilbúinn :)

# Furðufugl Gríma

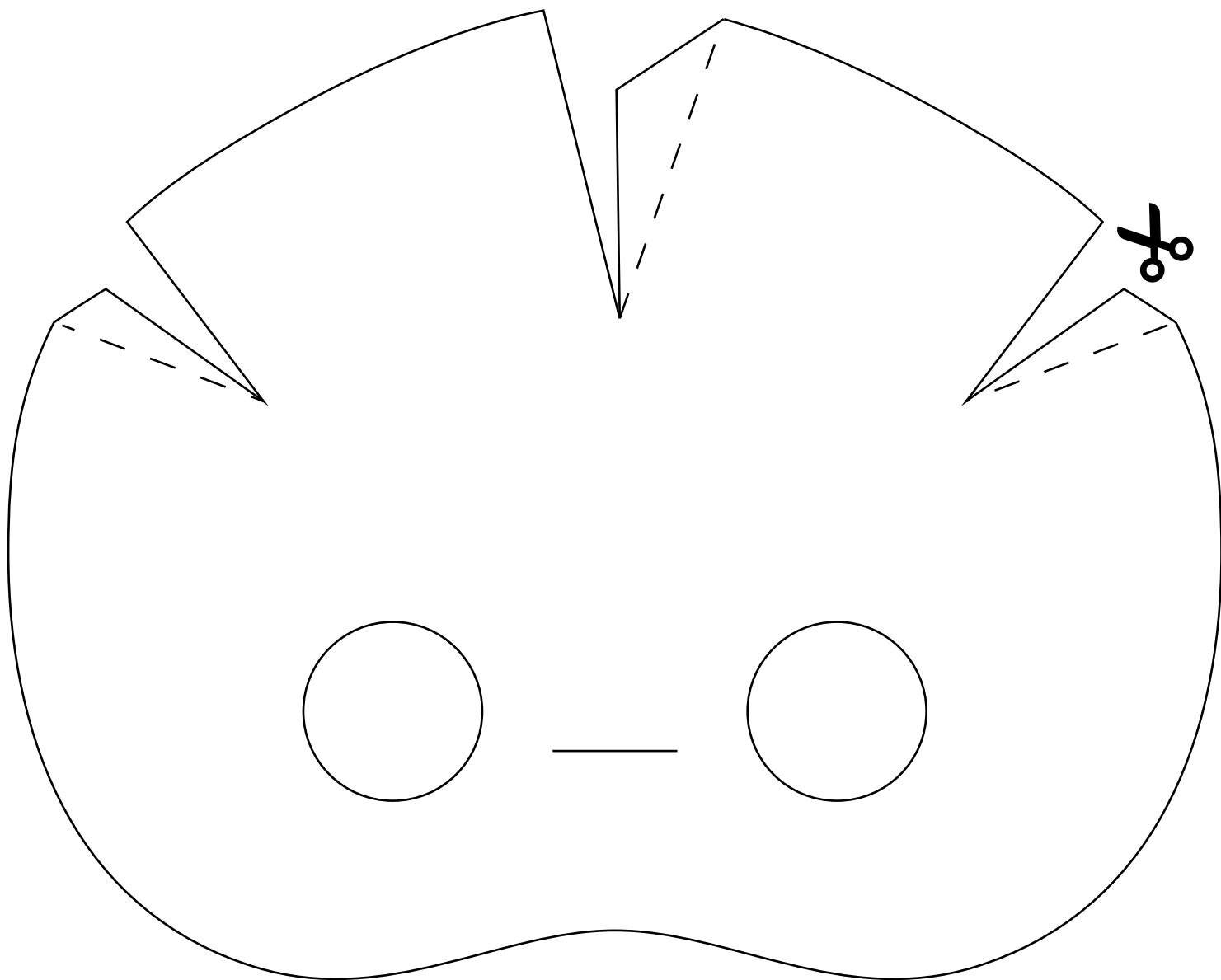

# Furðufugl

## Goggur 1

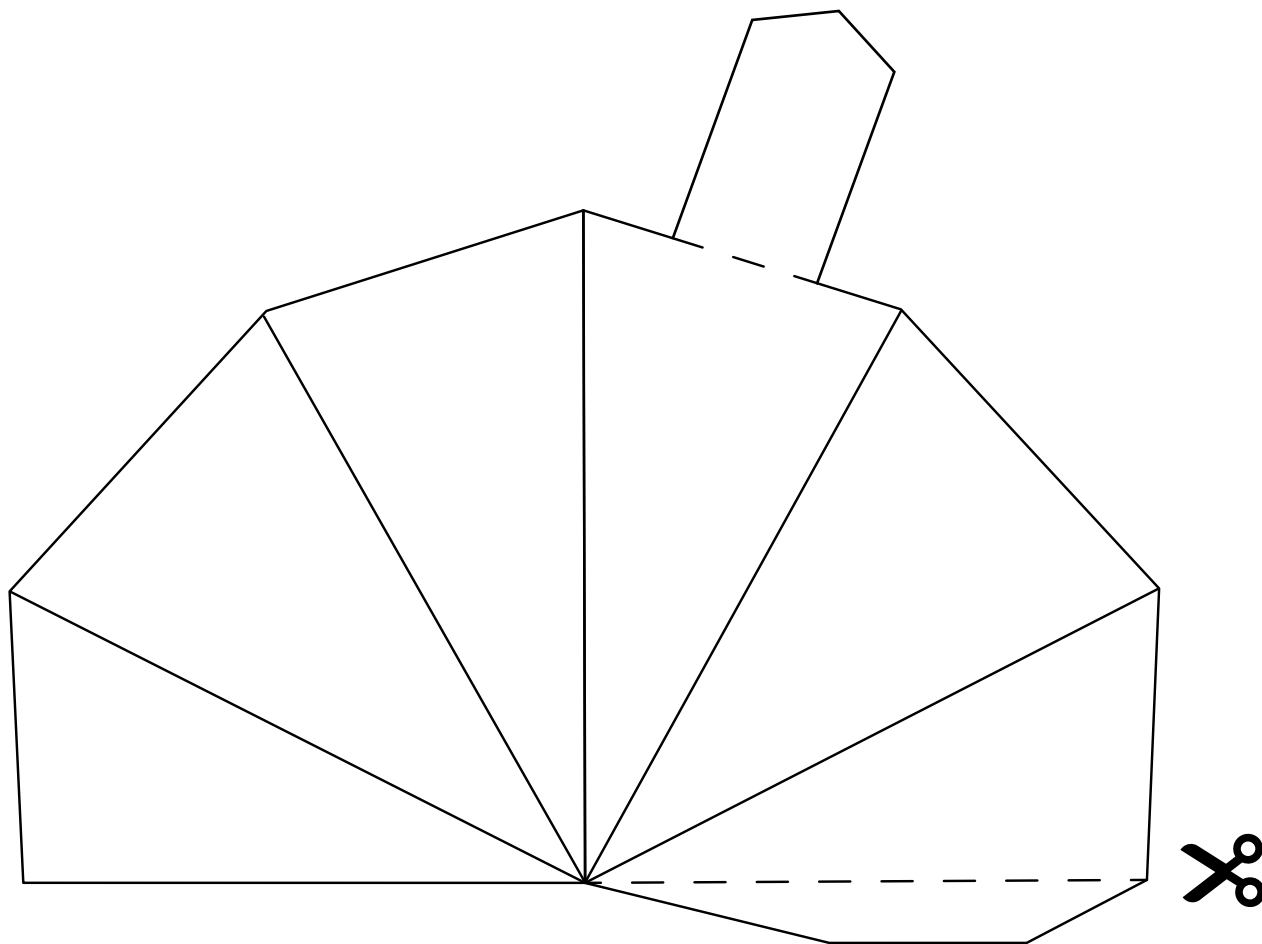

Furðufugl  
Goggur 2

